



Operating Instructions

LCD DIGITAL MICROSCOPE



Leuchtturm[®]

World Leaders in Collectors Accessories. Since 1917.

CONTENTS

Safety instructions	3
System requirements	4
Package contents	4
Device view and keypad	5
Starting up	7
Turning on/off	9
Image capturing	9
Recording videos	9
Play back	10
Play back menu	11
Image settings	12
Basic settings	13
PC software installation	15
PC software manual	16
Image settings	18
Calibration	18
Technical data	20
Contact/environmentally sound disposal	21

DISTRIBUTOR:

Leuchtturm Albenverlag GmbH & Co.KG

Am Spakenberg 45

D - 21502 Geesthacht

Tel.: +49 (0) 4152/801 – 0 (Monday - Friday from 8:00 a.m. – 5:00 p.m CEST)

Fax: +49 (0) 4152/801 - 222

E-Mail: info@leuchtturm.de

Internet: www.leuchtturm.com

Aforementioned information subject to change without notice.

PLEASE READ THE SAFETY INSTRUCTIONS CAREFULLY BEFORE THE INITIAL USE OF THIS MICROSCOPE.

General

- Never place the device on an unstable surface. The device may be damaged if dropped.
- Keep the device away from children. It is not a toy.
- Please also note the safety instructions and operating instructions of the other devices to which the device is connected.
- In commercial and industrial establishments, the accident prevention regulations issued by the trade associations for electrical systems and equipment must be observed.
- In schools, training centres, hobby or do-it-yourself workshops, the operation of electronic products should be responsibly monitored.
- If you have any questions regarding this device, its operation, safety or proper connection, please contact our customer service department.
- The seller and or distributor assume no responsibility for any losses occurring while using the device, or for third- party claims.

Environmental conditions

- Avoid placing heavy mechanical loads on top of the device. Protect the microscope from vibration and forceful collisions. Do not drop or shake the device.
- Do not expose the device to high temperatures (above 60°C) or dramatic temperature fluctuations. Protect the microscope from direct sunlight. Do not place it in the vicinity of heating appliances.
- Protect the device from humidity. Do not use the device in rooms with high humidity e.g. bathrooms.
- Protect the device from dust. Do not use the device in a dusty environment.
Also, it cannot be ruled out that some paints, plastics or furniture cleaners may damage the material of the housing or accessories. To avoid undesirable marks on furniture, keep the device away from sensitive surfaces.

Potential Hazard

- If an object or liquid should get into the device, arrange for it to be checked by a qualified technician before reuse. We recommend contacting our customer service department should this occur.

Rechargeable battery

- Rechargeable batteries (battery pack or inserted batteries) must not be exposed to excessive heat such as sunshine, fire or the like.

Cleaning and care

- Always store the device in a clean, dry place.
- Use a soft dry cloth to clean the exterior surfaces, such as the enclosed cleaning fabric.

SYSTEM REQUIREMENTS

- Operating system: Windows XP SP2 / Vista / 7 / 8 / 10 and MAC OS from 10.6 (measuring software only works with Windows)
- Minimum processor Pentium 1800 or comparable AMD processor
- 100 MB of free hard disk space
- Minimum 32 MB RAM, 512 MB RAM recommended
- 24 bit colour video card
- Free USB 2.0 port
- CD-ROM drive

PACKAGE CONTENTS



LCD digital microscope



Lithium-ion battery



MicroSD memory card 4 GB



Power adapter



USB cable



AV cable



CD (software, operating instructions) and Quick Start Guide



Cleaning fabric



Measuring table

MICROSCOPE OVERVIEW



KEYPAD AND NAVIGATION



INITIAL OPERATION



Inserting battery

Gently press the lever mechanism on the bottom of the device and remove the battery compartment cover. Then, with the polarity markings at the top left corner, insert the Lithium-ion battery into the battery compartment. For the sake of safety, the polarity is also printed on the battery compartment.

Charging the battery

Plug the Power Adapter cable into the microscope power supply port. Then plug the other end into an electrical power source. The battery requires approximately 3 hours to fully charge. During charging, the battery charging indicator light luminesces red. When the battery indicator light turns off, the battery is fully charged. A full charge provides approximately 4 hours of operation.

i The battery is also charged while connected to the USB port on a computer.

Battery status/charge status

The battery charge status is shown at the bottom right of the display window. LED brightness and image quality are additional indicators of the battery charge. If the battery charge is weak, the illumination and the image quality will be reduced.

Inserting the micro SD card and SD card status display

Turn off the digital microscope. The micro SD card slot has a spring mechanism. When the SD card is inserted into the slot, the card locks into place.



The SD card icon appears on the right side of the display window.

Before capturing images, the SD card must be formatted (see on page 14).

i Do not apply force when inserting the SD card into the SD card slot.



ON/OFF

To turn ON or OFF please press the **On/Off** key.

IMAGE CAPTURE

1. Turn on the device, as described above.
2. Place a specimen on the specimen platform.
3. To insert the specimen, move the specimen platform in the downward direction with the control knob to the right. Then move the specimen slide in the upward direction into the vicinity of the microscope aperture.
4. Magnification occurs in the image field by adjusting the magnification setting, utilising the knurled wheel (4) and adjusting the specimen stage height with the right control knob. When the specimen on the platform is brought up to the bottom part of the microscope, it is possible to turn the knurled wheel to the right (+) to adjust a second focus for maximum magnification.

i When the specimen is close up, there are two options for magnifying the specimen and focusing the camera (see 3 + 4)





5. Fix the specimen slide into position with the knob on the left hand side (LOCK).

i The control knob on the left (LOCK – UNLOCK) sets the resistance of the specimen platform control knob on the right (UP – DOWN). As the knob is tightened, the adjustment of the specimen platform becomes increasingly stiff.

6. Set a suitable LED brightness.
7. Digitally magnify the view utilising the “Zoom” lever (see page 10).
8. Press the image capture button.







i For subsequent measurements on the computer, capture an image with a millimetre scale using the set magnification or with the enclosed measuring table. Hold the device steady while pressing the image capture button, or risk that the photo is blurred. Read more about this in the “Timer” section on page 12.

RECORDING VIDEOS





9. To switch to video mode, repeatedly press the  key until the video icon  appears at the top left. To start recording press the image capture button 8. To stop recording, press the image capture button again.
10. Two resolutions are available in video mode: VGA (640 x 480 pixels) and QVGA (320 x 240 pixels). To change the resolution, press the  key and then select between VGA and QVGA. Exit the menu by pressing the  key.



PLAY BACK

You access the Play back menu by repeatedly pressing the   key until the play back icon  appears at the top left. If only videos are stored on the card, the icon  is displayed. You can scroll between photos or videos with the / keys.

Navigation

- Start play back by pressing the  key.
- For pause press the  key again.
- To fast forward or rewind during play back, press the / keys.
- Stop fast forward or rewind with the  key.



Zoom

To adjust the digital zoom (1x to 4x), find the zoom lever on the exterior of the display screen. The zoom factor is shown at the left of the display.

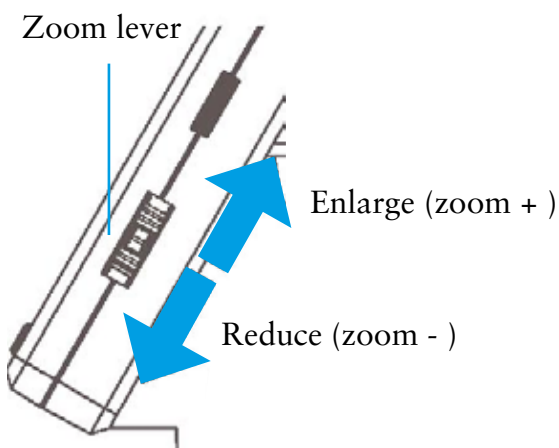
 In play back mode, a thumbnail view of images can be displayed by pressing the zoom lever in the “minus” direction (-).



Display (available in the photo function only)

To switch between colour and greyscale, press the  +  key. The changeover is in the following sequence: colour, greyscale as a positive image and greyscale as an inverse or negative image.



PLAY BACK MENU

During play back, you can access the play back menu by pressing the  key.

Select one of the following functions: Delete, Protect or Slide Show.



Navigation

-  : Selection of menu item
-  : Exit menu
-  : Confirm selection, perform action

Delete: Choose between deleting the file currently shown on the display or all of the files. To delete, select **OK/ Execute** in the subsequent confirmation prompt.

File protection for photo or video files:

In the following selection, you can protect the image on the display or all images against deletion or remove the existing protection:



- Lock one: protect the displayed image
- Unlock one: remove the protection for the displayed image
- Lock all: protect all images
- Unlock all: remove protection on all images

 For protected images, a key is shown at the top of the display window.

Slide Show: Start a slide show. In a submenu, the frame rate can be set to 2, 5 or 8 seconds. To exit, press the  button.

MAIN MENU / IMAGE SETTINGS



To access the main menu, press the  key. Select one of the following functions: Resolution, Time Lapse, Quality or Sharpness. To return to the previous menu, press the  key. To exit the menu, press the  key.



Resolution

VGA, 1.3, 3.0, 5.0, 9.0 and 12 megapixels are available for selection.

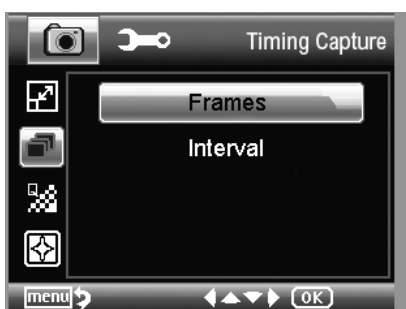

Timer

With the timer function, a fixed number of images (frames) can be captured automatically at preset intervals.

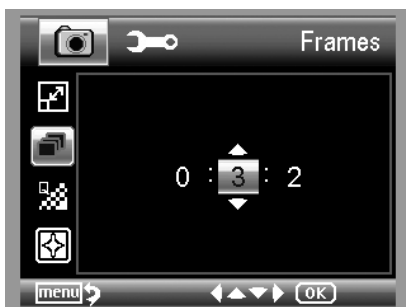

Frames

Set the number of images to be taken. In the example shown on the left, 32 images are captured.



Interval

Set the time interval to determine when the images are to be captured. In the example shown on the left, an image is captured every 15 seconds.



To prevent shaking the microscope while capturing a single image, set the interval to 0:0:0 and exit the menu. Next press the image capture button. A photo is taken after a delay of 1 second. Changing the digital zoom results in premature termination of the timer function.



Quality

Select the size / compression rate of the JPG file.

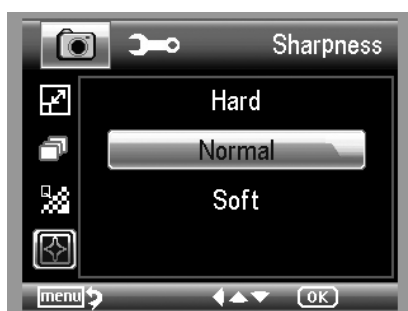

Sharpness

Set the sharpness for angular objects in the image.

MAIN MENU - BASIC SETTINGS

To access the main menu, press the  key.

Date display, language, date and time and other settings can be made here:



Language

Set desired menu language.



Power Save

When the energy saving mode is on, the unit automatically switches off after the preset time. Setting this mode extends the service life of the rechargeable battery. To deactivate the energy saving mode, select **OFF**.



Date Stamp

Here choose the format of the date and time.



TV Out

This device has an AV output capacity. For Europe, set the TV standard to PAL. Connect the TV device to the microscope using the supplied AV cable. The monitors adapt automatically.



Date/ Time

First set the date format (e.g. DD/MM/YY). To access the format setting, use the ◀ button. Then set the date and time.

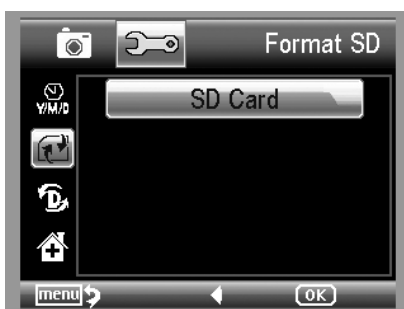

Formatting SD

Note: The SD card must be formatted before use. During the formatting process all data is deleted. For this reason a warning message is displayed. You must confirm selection with **OK/ Execute**. If this menu item is selected by mistake, choose **Cancel**.



System Reset

This function resets all settings in the menu to the original settings.

Version

Shows the current software version on the display.

PC SOFTWARE INSTALLATION

No drivers are required for the installation of the device.

- Insert the supplied CD into the CD drive.
- If the installation does not start automatically, on the CD select “setup.exe” to install the software on the computer.
- The software installation runs completely independently.
- For the remainder of the installation, follow the installation wizard.
- For software installation on MAC OS reference the MAC folder on the CD.

Connect the device to the computer

Connect the LCD Digital Microscope to a computer using the supplied USB cable.

The display window will automatically turn on and display a selection of functions.



- To view a live image in the PortableCapture software select **Preview on Computer**.
- To import photo(s) and video(s) from the SD card into the database, or to import the photo and video directory of the PortableCapture software, select **Upload Images**.
- The computer requires a moment to install the software.
- Start the software from the desktop.

 Please set the brightness! An incorrect setting may cause a blank screen to be displayed.

PC SOFTWARE MANUAL

The following pages explain how to use the PC software.

- The program interface is multilingual. To choose a language, select **Options > Language > English**.
- The captured or imported image is displayed on the right hand side as a thumbnail.



Thumbnail image display

Preview window

- When the mouse is over a thumbnail, the image appears in the **preview window**. When you click the right mouse button, a submenu opens, which displays the following options:
 - Click **Open** to see a preview image
 - Click **Save** to save the image
 - Click **Copy** to save the image to the clipboard for further processing
 - Click **Delete** to delete the image

When **Save** is selected, a dialogue box opens which allows you to choose the file name and file storage location.

- To **save a single image**, click the photo camera icon at the top of the window or press the F11 key. Photos are stored in the “Photos” folder. The captured image is displayed on the right side of the monitor as a thumbnail image.
- Video recording starts when the video camera icon at the top of the window is clicked or by activating **Capture > Video**. Recording stops when the icon is clicked again. Videos are saved in the “Videos” folder.

 In PC camera mode, the image size is limited to 320 x 240 and 640 x 480 pixels.

MAIN MENU BAR / TOOLBAR

File

- Photos directory: Directory where the images are stored.
- Videos directory: Directory where the videos are stored.
- Import: Import images from the SD card.
- Exit: Exit the program.

Options

- Resolution: Under this menu item you can set the size of the preview image.
- Date / time: To display the date and time on the image.
- Language: To set the menu language.
- Fullscreen mode: To switch between normal and full screen display. To change to the normal display, double-click the image display.
- Crossing: To display a crosshair.

Capture

- Photo: Captures a single image.
- Video: Starts a video recording. Click again to stop recording.

TIMER FUNCTION

The Timer icon is displayed in the toolbar. The Timer icon is used to capture images at preset intervals.

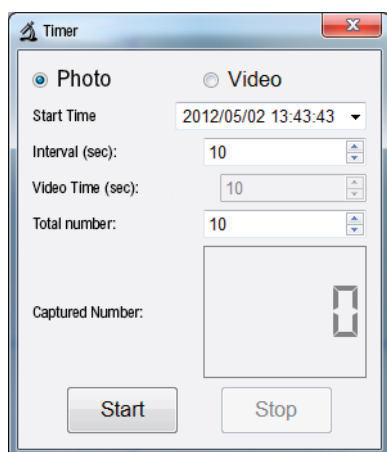

- Select **Photo** or **Video**.
- Click the arrow on the right to set the **date**. Click to determine the hour, minute and seconds position. Then click the right mouse button. In the next menu display, adjust the time with **Step up** and **Step down**.
- **Interval (sec)**: Set the interval in seconds to preset the intervals at which the images are to be captured.
- **Video time (sec)**: In “Video” mode this is the length of time a video shall be recorded.
- **Total Number**: The number of images.
- For longer time intervals, it is useful to see how many images have been taken. You can obtain this information under **Captured number**.
- To start click **Start**; to stop click **Stop**.

Image sizing

As the main program is installed, software is also installed that allows you to resize image(s).

To utilise this feature, double-click on an **image in the gallery** on the right hand side. At the bottom of the window a slider is displayed which is used to enlarge or reduce the image size. Save or delete the edited image, and/or copy it to the clipboard, etc.

An explanation of the individual icons is listed on page 19.



Calibration

The new calibration function allows accurate measurements to be made while capturing an image. Adjust the knurled wheel, on the microscope, place the **measuring table** (or optionally a **millimetre gauge**) on the specimen platform. Then press the “Capture” button to capture an image. With this image you can make measurements on all photos that were captured at the same magnification. Although it is most accurate to include the measuring table with each specimen while capturing each image.

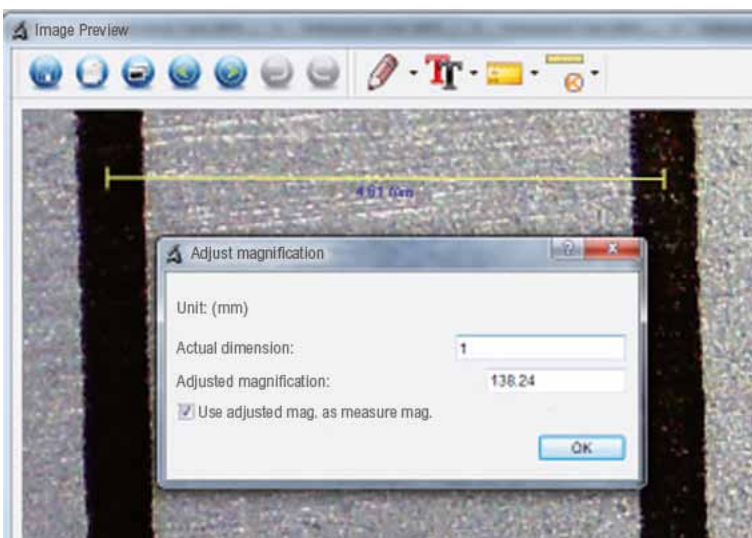

Open the image in the image preview. Click **Calibration** . Based on the picture above, use the mouse to drag a line from the left edge of the millimetre mark to the left edge of the next mark. A window will display, to prompt you to enter the displayed measurement. In this case, it is 1 mm. Confirm with clicking **OK**.

Click the  icon. You can now make measurements in the image.

TOOLBAR

Date display, language, date / time and other settings can be determined here:



Save as

Copy to clipboard

Copy file

Previous / next image

Undo / Redo

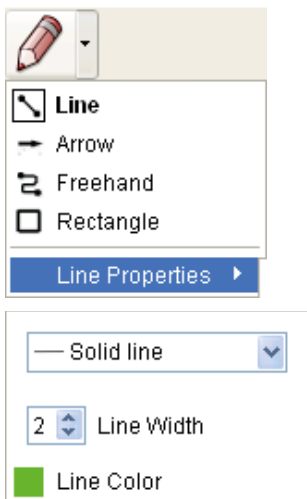

Drawing

The “Drawing” menu provides various tools:

Line, arrow, freehand, rectangle.

You can set the line properties in a submenu.



Note

Select the font and text colour for the text input here.

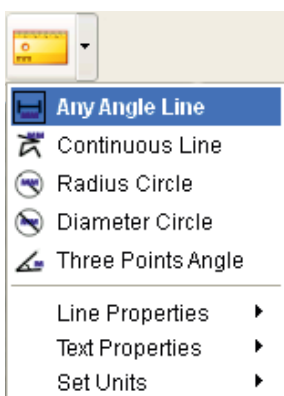

Measuring tools / ruler

- Lines with dimensional accuracy
- Circle with radius and diameter
- The following data is displayed here: radius R, circumference C and surface area S
- Angle measurement
- Properties of lines and text
- Set unit: mm, cm, pixels and inches

TECHNICAL DATA

Image sensor:	5 megapixels (CMOS sensor)
Display:	7.6 mm (3.5", LCD)
Video:	Resolution 640 x 480 pixels, 320 x 240 pixels (VGA)
Single image:	Resolution 12 M (4032 x 3024), 9 M (3456 x 2592), 5 M (2592 x 1944), 3 M (2048 x 1536), 1.3 M (1280 x 960)
Colour:	24 bit RGB
Optical system:	Dual lens 27x + 100x
Flicker frequency:	50/60 Hz
Frame rate:	max. 30 frames
Magnification:	approx. 10 and 20x, 500x (based on resolution of 5 megapixels)
Shutter speed:	1 sec. to 1/1000 sec.
Image format:	JPG
Video format:	AVI
White balance:	Automatic
Exposure:	Automatic
Working area illumination:	8 LED, white, continuously adjustable on device
PC interface:	USB 2.0
Operating system:	Windows XP SP2 / Vista / 7 / 8 / 10 / MAC OS 10.6 or higher
Power supply:	Lithium-ion Battery 3.7 V/800 mA, 5 V (USB port), power adapter
Dimensions (housing):	103 x 146 x 230 mm

Problem	Suggested Solution
The device does not turn on.	Charge the battery.
The screen is blank.	Confirm device is turned on. Confirm battery is charged. Make sure that the specimen to be magnified is placed correctly under the lens. See Mikroscope Overview on page 5.
Dirt or imperfections on the screen.	Carefully clean the screen and lens with the enclosed cleaning cloth.
Microscope is connected to the TV device, but no image displays on the screen.	Make sure that the TV device is turned on. Set the TV device to the correct video input. Confirm the video cable is securely connected to the video output of the microscope and the video input is securely connected to the TV device.
The battery charger indicator does not light-up in red when the power supply is connected to an outlet. -Or- the battery does not charge.	Connect to the DC input of the microscope. Confirm the electrical socket is functioning properly.

SERVICE PROCEDURE

For complaints or defective products, please contact your seller or the distributor (LEUCHTTURM) directly:

Contact information:

LEUCHTTURM Albenverlag GmbH & Co. KG

Am Spakenberg 45

21502 Geesthacht

Germany

Tel.: +49 (0)4152/801 – 0 (Monday - Friday 8:00 a.m. – 5:00 p.m. CEST)

Fax: +49 (0) 4152/801 – 222

E-Mail: info@leuchtturm.de

 Please do not send your device to LEUCHTTURM without having been requested to do so. The costs and risk of loss are the responsibility of the owner/sender. We reserve the right to refuse acceptance of unsolicited consignment, and will return the respective product to the sender at the owners'/senders' expense.

ENVIRONMENTALLY SOUND DISPOSAL

This device is labelled according to the European Directive 2002/96/EC for electrical and electronic equipment waste. Please use the collection points provided by your local authority for the disposal and recycling of electrical and electronic equipment waste.



Do not dispose of Lithium-ion battery in household waste.

Please recycle used batteries at proper recycling collection facilities.

